

Data Sheet



Article number: 0128084

Description: Circlip RW 75 DIN 7993

Measures

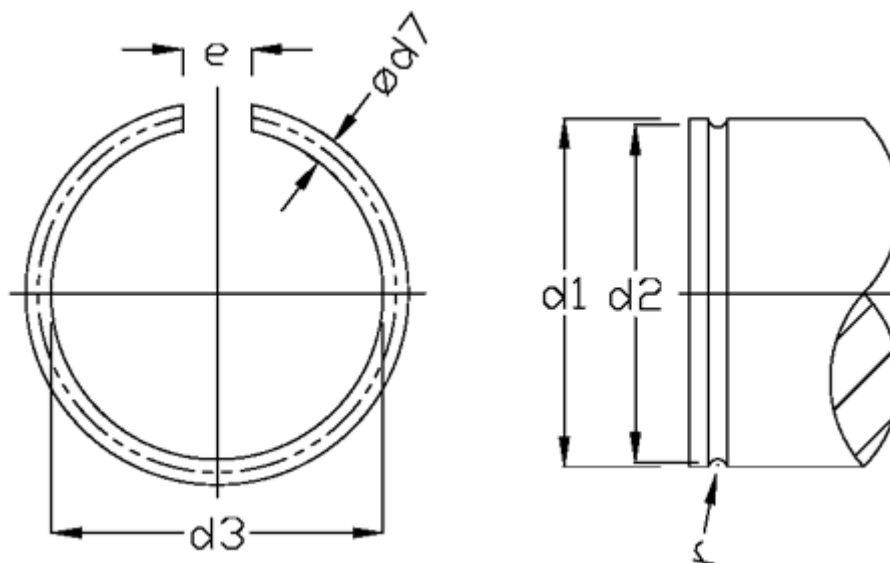

d1	= 75	tol	= 0.15
d2	= 71.8	tol	= -1.0
d3	= 71.0	Weight kg/1000	= 14.390
d7	= 3.2		
Description	= RW 75		
e	= 5		
n abl x 1000	= 2		
r	= 1.8		